

What's New in Solid Edge ST10 Portfolio

boundary representation (b-rep) solid models with triangular mesh models without time-consuming and error-prone conversions. With the introduction of Siemens' Convergent Modeling™ technology in Solid Edge ST10, traditional b-rep operations can be performed on digitally scanned 3D data and models created from topology optimization. This integration reduces rework while supporting modern additive manufacturing processes for complex shapes.

Shaping the future of product development

Benefits

- Seamlessly work with mesh models alongside traditional 3D data without time-consuming conversions
- Minimize mass and material usage using automatic topology optimization
- Interact naturally through free hand pen sketching; break the mouse barrier
- Accelerate work within large assemblies
- Print 3D designs on local devices or submit them to a global network of 3D printing services
- Perform fluid flow and heat transfer analyses to optimize product performance and reliability
- Publish effective technical illustrations and manuals directly from Solid Edge models
- Built-in Solid Edge data management is even easier to install and even more productive

Summary

The Solid Edge ST10 portfolio of products from Siemens brings every aspect of your product development to the next level. It gives you the very latest in next generation design technologies, fully integrated flow analysis, the newest tools for 3D printing and more options for creating technical publications. You'll have perfect control of design data at any scale, along with a brand new way to collaborate securely on the cloud.

Convergent Modeling

Solid Edge® software advances innovation and improves design productivity by seamlessly combining traditional

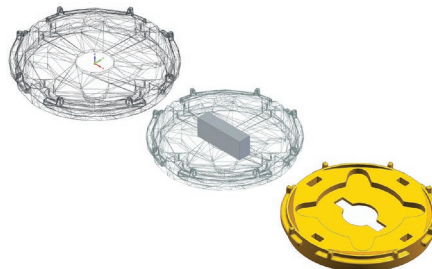

Generative design

Solid Edge ST10 integrates advanced topology optimization within the Solid Edge 3D modeling toolkit, helping designers to create lighter components, minimize material waste in downstream manufacturing, and also create highly customized designs well-suited for casting or high-resolution 3D printing. Obtain a reduced-mass geometric solution of a specific material optimized within a design space, accounting for permissible loads and constraints. Immediately manufacture the body via additive processes, use it as a core for mold base design, or use the Solid Edge toolkit to further refine the shape for traditional manufacturing.

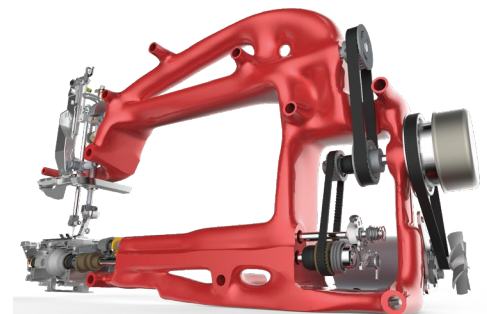

What's new in Solid Edge ST10

Benefits *continued*

- Wider support for part classification, working offline and engineering-to-order processes when working with Teamcenter
- Collaborate easily with suppliers and customers using cloud-based vaulting, viewing and markup

Features

- Next-generation modeling tools allow easy addition of features to scanned models
- Generative design tools enable the modeling of complex, organic shapes
- Reverse engineering tools reduce rework on imported and scanned models
- Cloning speeds duplication of frequently-used components within a product assembly
- Dedicated 3D printing interface features dynamic preview with associated topological information, with multiple export options to common formats
- Online professional 3D printing services are available directly from Solid Edge
- Solid Edge Flow Simulation delivers embedded CFD to a wide range of users
- Find the data you need faster – including associated draft files and latest revisions
- Support for part classification, off-line working and assigning Solid Edge files to existing items in Teamcenter
- Solid Edge Portal for cloud-based collaboration around multi-CAD data

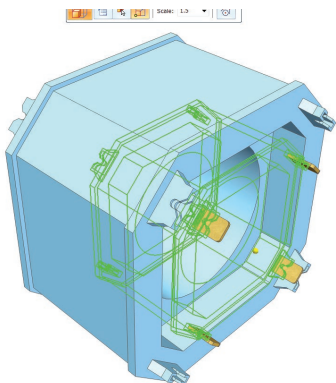

Reverse engineering

Many teams design products utilizing components imported from other CAD systems. With the rapid growth of high-resolution 3D scanners, even legacy parts designed on the drawing board can be digitally represented and modified to suit contemporary designs without complete reconstruction. Solid Edge delivers tools that speed your reverse engineering workflows.

- Mesh cleanup tools help to obtain bodies more conducive to modification and eventually downstream manufacturing. Delete unwanted meshes, and even repair defects such as gaps and holes.
- Region identification commands analyze triangular mesh regions and categorize them as traditional entities such as planes, cylinders, spheres and b-spline surfaces.
- Surface extraction techniques assist in converting identified mesh regions into faces that can be manipulated via Solid Edge's powerful surface design tools.

Synchronous modeling

- Model scaling: Models can be scaled up or down, uniformly or non-uniformly, in preparation for conceptual prototype design and 3D printing, and accounting for shrinkage in mold design.
- Free hand sketching (Draw command): Mobile design is advanced via the introduction of Microsoft Inking technology for freehand sketching within the Solid Edge Draw command. When working with a Surface device, pen strokes are converted to analytical sketches on the fly, truly making the tablet a "digital napkin."

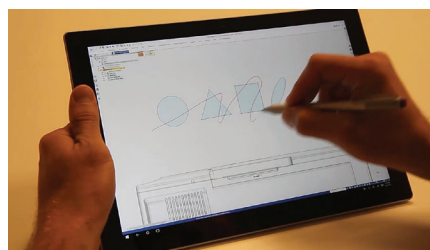

- 3D sketch Improvements: Now all 3D sketch curves can be split at specified key points with automatically generated relationships. And, routing lines are defined by and behave as 3D sketch curves created between all types of key points. This makes routes available in all design environments, with display properties common to curves.

Sheet metal

- New wrap cut functionality preserves circular and linear cutouts across bends in synchronous sheet metal parts.



Assembly

- Assembly feature and relationship suppression variables: Solid Edge ST10 provides the ability to programmatically assign suppression variables to individual assembly features and relations, speeding modification during assembly edits. From there, the variable table can be used to tie suppression states to logical functions.
- Assembly clones: Modeling productivity is greatly enhanced by component cloning, automating the duplication of single parts or subassemblies across an entire top-level assembly. Each clone can be oriented as needed. Relations associated with the component(s) will be duplicated when similar reference geometry exists, or will be repaired if necessary.



Manufacturing

- Solid Edge exports to the lightweight 3D Manufacturing Format (3MF), simplifying additive manufacturing of individual parts and flattened assemblies.
- Desktop 3D printing: Solid Edge provides a dedicated 3D printing interface featuring a dynamic preview with associated topological information, fully integrated with Microsoft's 3D Builder facility. Set tolerances, scale or reorient the model and validate it for errors before exporting an STL or 3MF result.

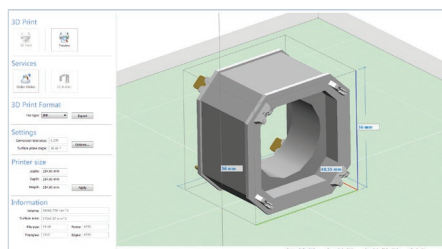

- 3D printing with cloud services: Now you can upload your model to the embedded 3YOURMIND cloud printing service, which provides options for materials and costing from printing services across the globe.

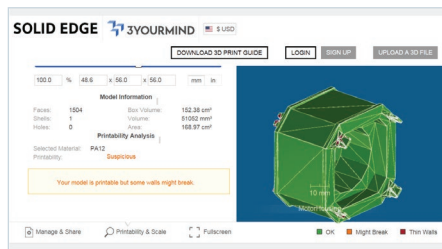

- A new bundle of CAM Express 2.5-axis machining together with Solid Edge is available that significantly reduces the cost of adding both CAD and CAM capabilities.

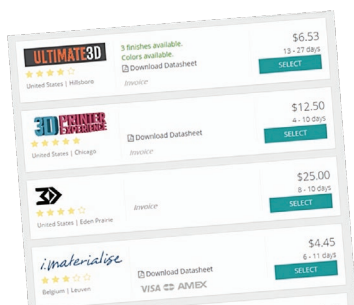

Drafting

When exporting Solid Edge drawings to AutoCAD, mechanical symbols reference AutoCAD fonts, eliminating the need for a Solid Edge font file.

Reversing drawing view creation and updates is as simple as selecting "Undo".

Background sheet geometry can be located for precise positioning of objects.

Simulation

Solid Edge Flow Simulation is a fully embedded and intuitive computational fluid dynamics (CFD) analysis tool that provides a wide range of users with valuable insight into product behavior from the beginning of the design cycle. The tight integration between native Solid Edge geometry and simulation data makes certain that all changes are synchronized, resulting in optimized product performance and reliability earlier in the product development process.

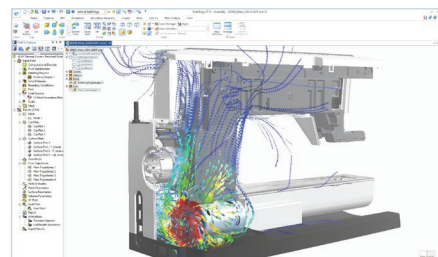

Technical publications

Solid Edge ST10 enables fast publication of manufacturing and assembly instructions, training manuals, spec sheets and more. Solid Edge Illustrations software creates illustration sets directly from Solid Edge geometry and product and manufacturing (PMI) annotations, while Solid Edge Documentation generates customizable, multi-page documents. The interoperability between these tools allows seamless creation of step-by-step process instructions from exploded views and multiple product configurations – even permitting use of multiple 3D models in a single document. Edits to Solid Edge models can automatically propagate to the publications.

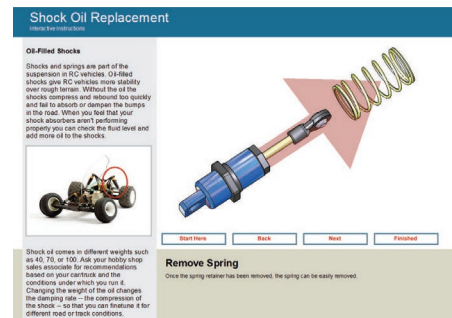
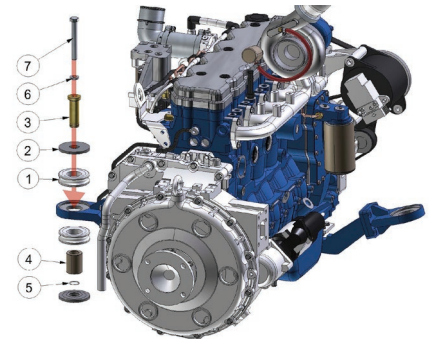

Built-in data management

Built-in data management capabilities are enhanced with even easier setup and administration, and improvements in the user interface help speed completion of everyday tasks and reduce errors in the design process. Notification of the availability of newer revisions, improved tools to find and replace duplicate files, and automatic copying of drawings during "Save As" operations are just a few of the many enhancements.

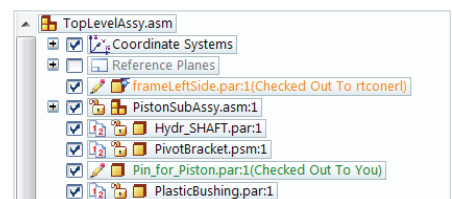
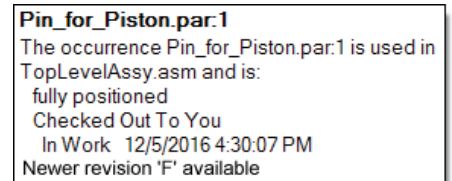

Teamcenter integration for Solid Edge

More work processes are now supported for Solid Edge customers using Teamcenter® software. Users can work offline and then synchronize the changes they have made to Teamcenter, and a new “Save New to Existing” command allows users to associate new Solid Edge files with existing Teamcenter items.

Classification of parts is supported through the embedded Active Workspace interface. Many user interface improvements including the ability to directly open associated draft files, validation of user input before submitting data and docking panes in the “Open File” dialog further improve efficiency and reduce the possibility of errors. New bundles of Solid Edge with Teamcenter provide great value for customers moving towards becoming a digital enterprise.

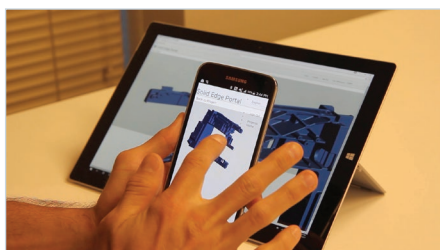
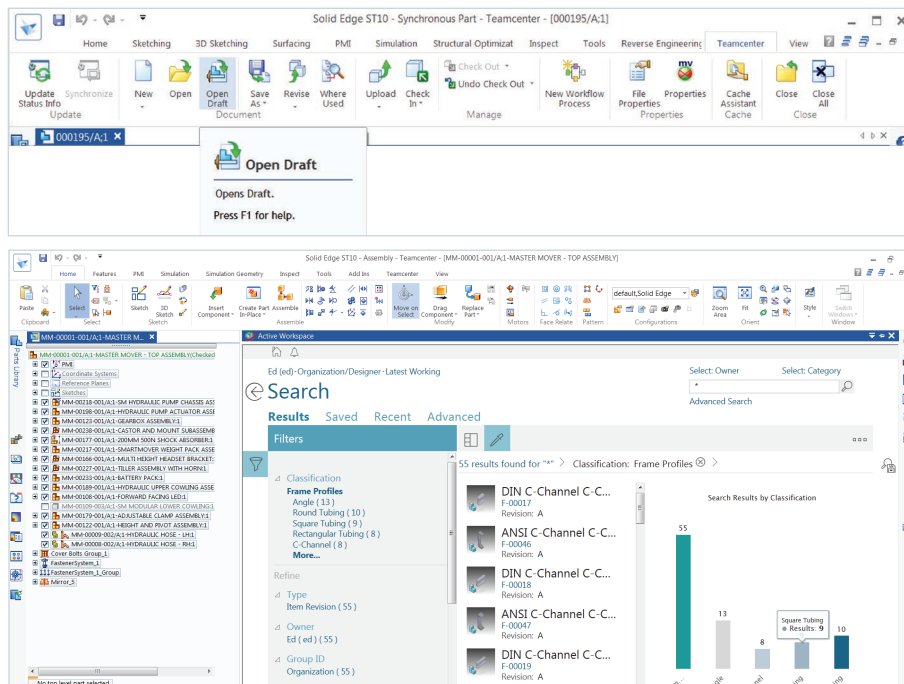

Solid Edge Portal

The Solid Edge Portal is a new way for manufacturers to securely collaborate around their design projects, both internally and externally. Upload your CAD files to cloud-based project folders, and view these files using any browser. Invite users from other departments or from external organizations including suppliers and customers to collaborate with you.

Siemens PLM Software
www.siemens.com/plm

Americas +1 314 264 8499
 Europe +44 (0) 1276 413200
 Asia-Pacific +852 2230 3308

© 2017 Siemens Product Lifecycle Management Software Inc. Siemens, the Siemens logo and SIMATIC IT are registered trademarks of Siemens AG. Camstar, D-Cubed, Femap, Fibersim, Geolus, GO PLM, I-deas, JT, NX, Omneo, Parasolid, Solid Edge, Syncrofit, Teamcenter and Tecnomatix are trademarks or registered trademarks of Siemens Product Lifecycle Management Software Inc. or its subsidiaries in the United States and in other countries. All other trademarks, registered trademarks or service marks belong to their respective holders. 63375-A16 5/17 A